



## Magnetic Autocontrol GmbH

Grienmatt 20  
D-79650 Schopfheim  
Tel. 07622 695-5

Job number

5526,0039

Type

MicroDrive - ACCESS XXL/ XL2  
with Option service socket

MHTM - MicroDrive - ACCESS XXL/ XL2- R/LA ... 0 0

Number of pages 6

Version	Date	Modification project	Name
09	17.06.16	5E16517	gp
08	12.02.16	5E15590	gp
10	15.02.18	5K18500	TO

MHTM  
MicroDrive - ACCESS XXL/ XL2



Cover sheet

		=	
		+	
5526,0039		Page	1
		of	6



controller

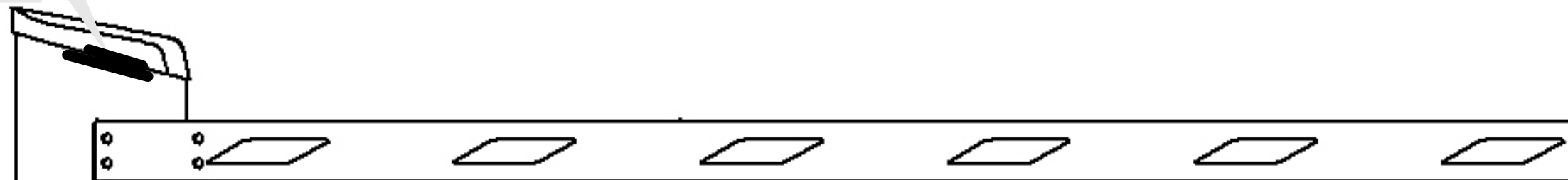

motor + gearing

light barrier transmitter



Option

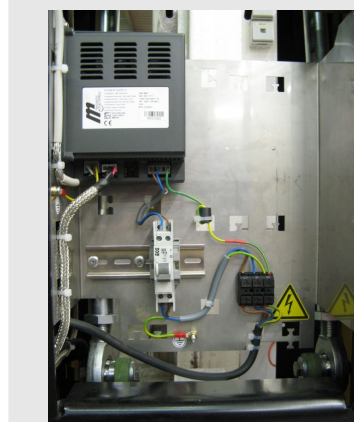

mounting panel

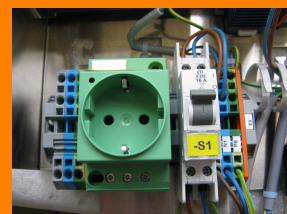

Option

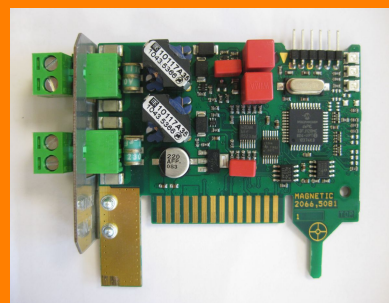

loops



Option

light barrier receiver



Option

09	17.06.16	5E16517	gp	16.01.2013
08	12.02.16	5E15590	gp	Probst
10	15.02.18	5K18500	TO	
Version	Date	Modification project	Name	

MHTM  
MicroDrive - ACCESS XXL/ XL2



ACCESS XXL/XL2

5526,0039

supply voltage controller

M1 /4.2

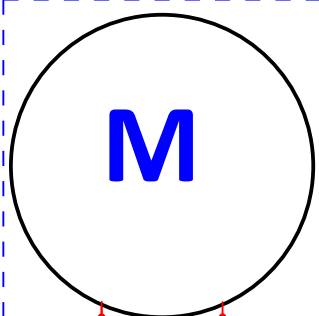

supply voltage motor

motor interface cable

M\_LK / 5.0

mounting panel 1031,5904

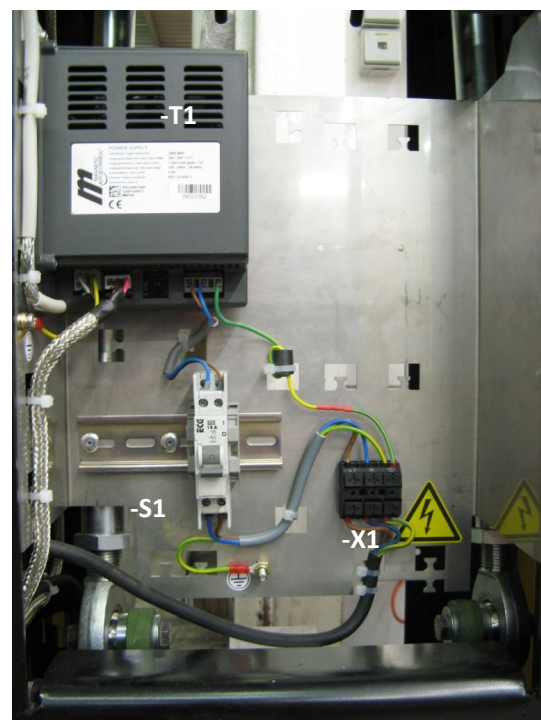
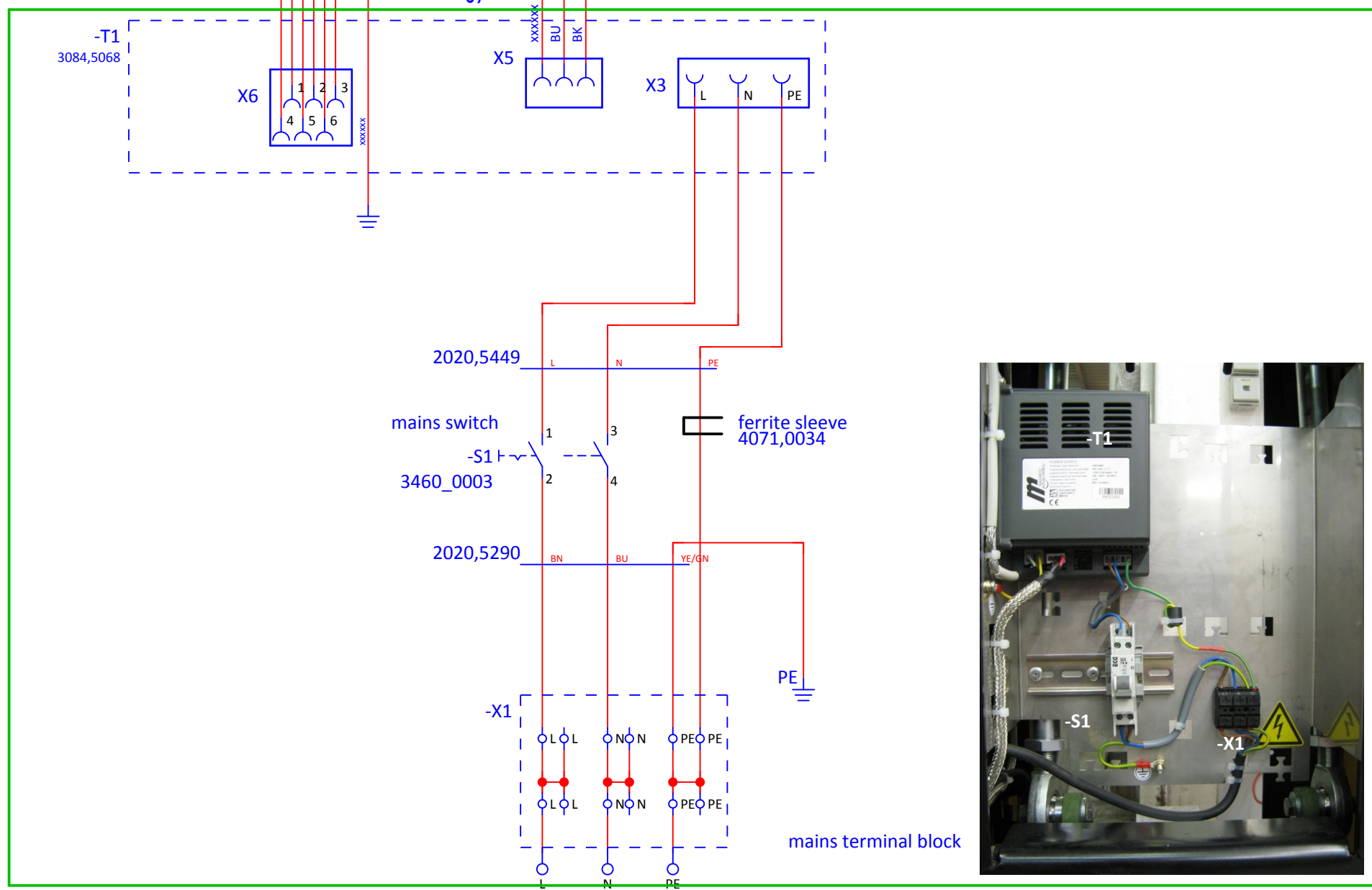

85 - 264V AC 50/60Hz

09	17.06.16	5E16517	gp	16.01.2013
08	12.02.16	5E15590	gp	Probst
10	15.02.18	5K18500	TO	
Version	Date	Modification project	Name	

MHTM  
MicroDrive - ACCESS XXL/ XL2



mains connection  
Power supply unit

		=
		+
5526,0039		Page 3
		of 6

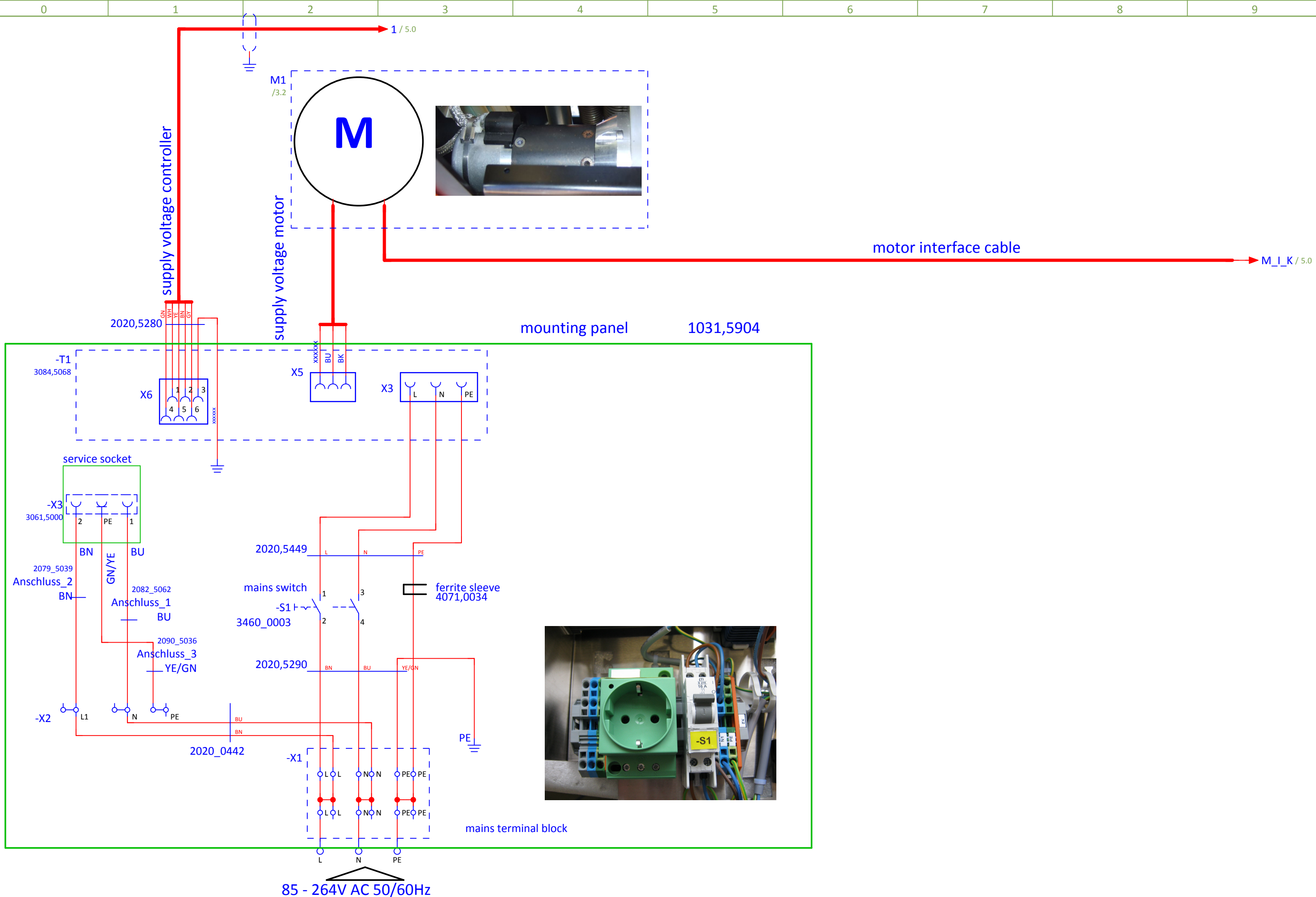

09	17.06.16	5E16517	gp	16.01.2013	MHTM MicroDrive - ACCESS XXL/ XL2		mains connection (Option) power supply unit with service socket	5526,0039	Page 4 of 6
08	12.02.16	5E15590	gp	Probst					
10	15.02.18	5K18500	TO						
Version	Date	Modification project	Name						

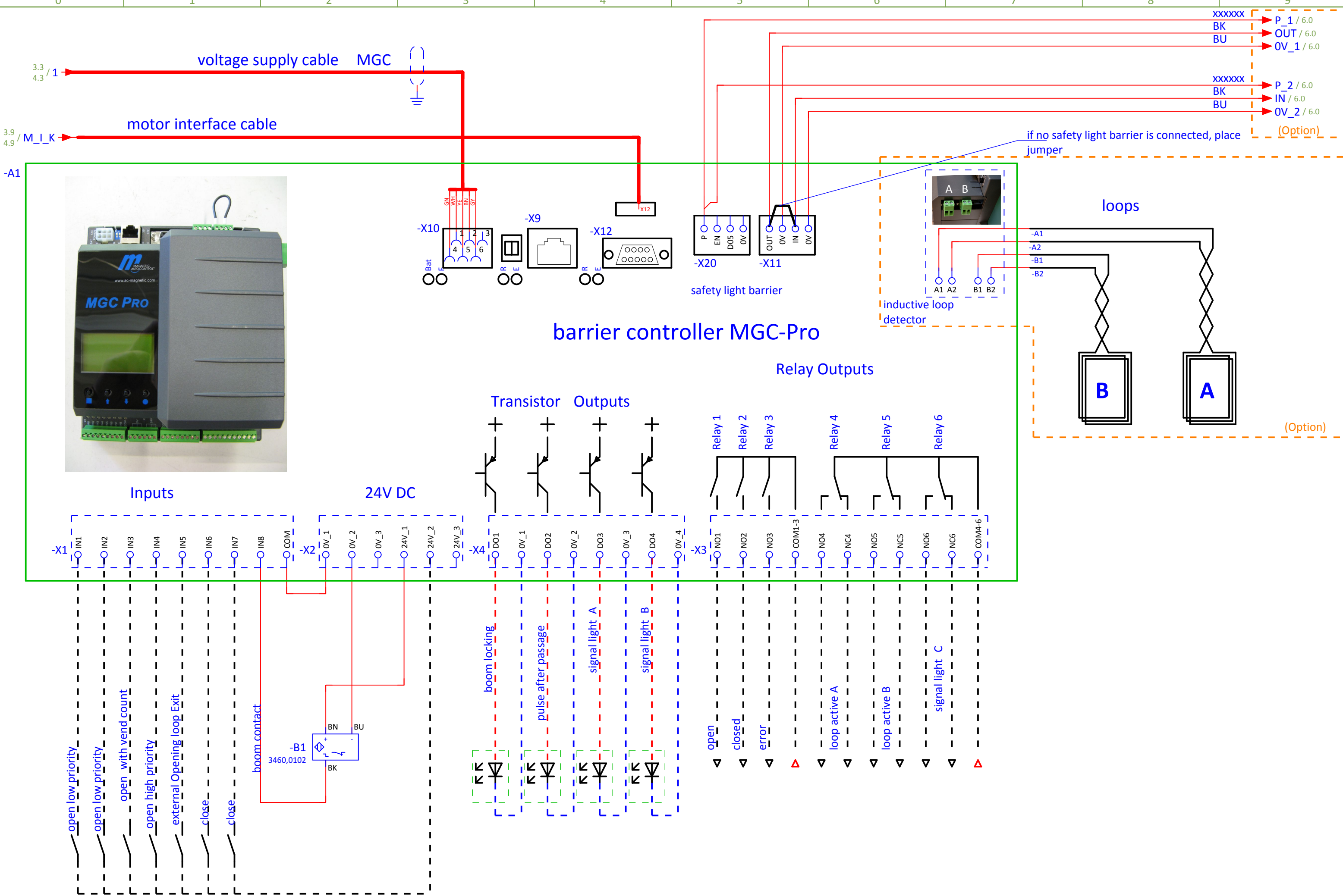

09	17.06.16	5E16517	gp	16.01.2013
08	12.02.16	5E15590	gp	Probst
10	15.02.18	5K18500	TO	
Version	Date	Modification project	Name	

MHTM  
MicroDrive - ACCESS XXL/ XL2



barrier controller MGC  
input/output

5.9 / P\_1 → BN  
 5.9 / OUT → BK  
 5.9 / OV\_1 → BU

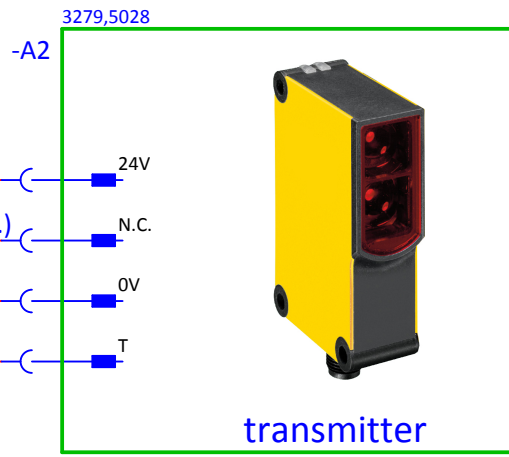

5.9 / P\_2 → BN  
 5.9 / IN → BK  
 5.9 / OV\_2 → BU

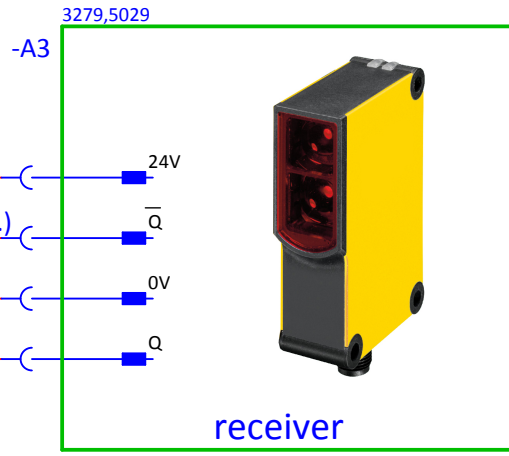

(Option)

09	17.06.16	5E16517	gp	16.01.2013
08	12.02.16	5E15590	gp	Probst
10	15.02.18	5K18500	TO	
Version	Date	Modification project	Name	

MHTM  
 MicroDrive - ACCESS XXL/ XL2



safety-light barriers Option  
 LS01